



Would you like to know more?

To receive further information, please contact your authorized dealer or visit our website: www.kodakdental.com

Powerful simplicity.
Surprisingly affordable.



Carestream Health
©Carestream Health, Inc., 2010.
The Kodak trademark and trade dress are used under license from Kodak.

3/25/2010

Kodak 80000/8000C
Digital Panoramic and Cephalometric System

■ A great product, made even better

We are committed to consistently improving our products and striving for diagnostic excellence. The new and improved version of the Kodak 8000/8000C digital panoramic and cephalometric system is just one excellent example of this.

Building on the success of the Kodak 8000 system, this new version provides dental professionals with the diagnostic quality and simplicity they need, with continued affordability. Delivering high image quality, quickly and effortlessly, the Kodak 8000 system is the perfect solution for basic panoramic and cephalometric exams.

■ New and improved

- **Enhanced image quality**
- **Ethernet connection for easier installation**
- **Cephalometric module design**





Develop panoramic vision

Simplicity, quality, and productivity

The Kodak 8000 digital panoramic system simplifies your practice.

Its streamlined user interface and computer-controlled system are designed for usability, while face-to-face positioning ensures easy patient placement.

Meanwhile, the system's cutting-edge technology quickly generates consistently clear images—safely and easily.

Simplicity. Productivity. Quality.

Kodak 8000
Digital Panoramic System



Care that's easy on everyone

Easier positioning

The Kodak 8000 system makes positioning patients simple. Unlike other systems that position the patient with his or her back to the operator, the Kodak 8000 system offers face-to-face positioning for easier placement and more comfortable exams. Now you can look your patients in the eyes—putting them at ease like never before.

Better diagnoses

Thanks to the system's open design, your patients will feel more comfortable—and greater patient comfort means less movement. This, in turn, helps ensure the clear, high-quality images you need to make accurate diagnoses.

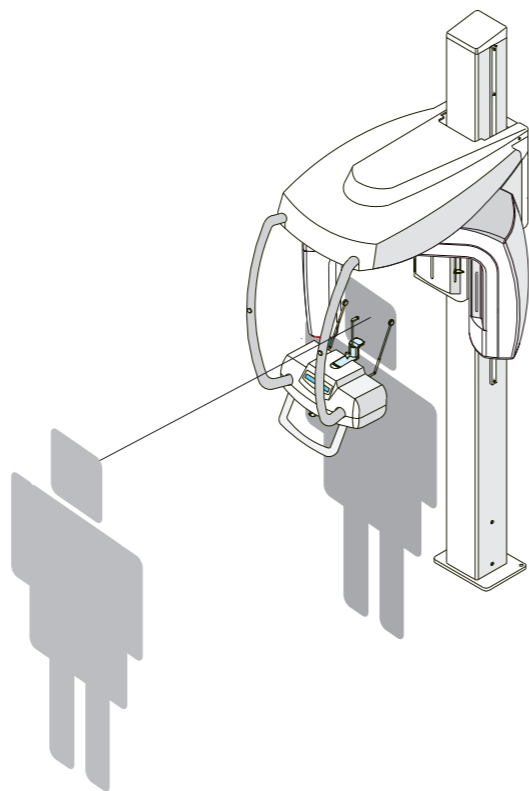

The Kodak 8000 system positions patients and dentists across from one another to help enhance communication. You can easily speak to patients and walk them through the process.



Laser beams allow easy and accurate positioning.



Simple as one, two, three

User-friendly

The Kodak 8000 system features an intuitive user interface that is the epitome of simplicity. It's so simple to operate and understand - even for the newest team members.

Easy and effective

The user interface is organized around very clear, intuitive icons and menus. The entire process unfolds according to a logical and clear sequence so you can prepare your exam and make exposure settings quickly and easily.

Time-saving

Since the Kodak 8000 system is so easy to use, you can focus more of your attention on patients—something both of you will appreciate.

1. Select the program.

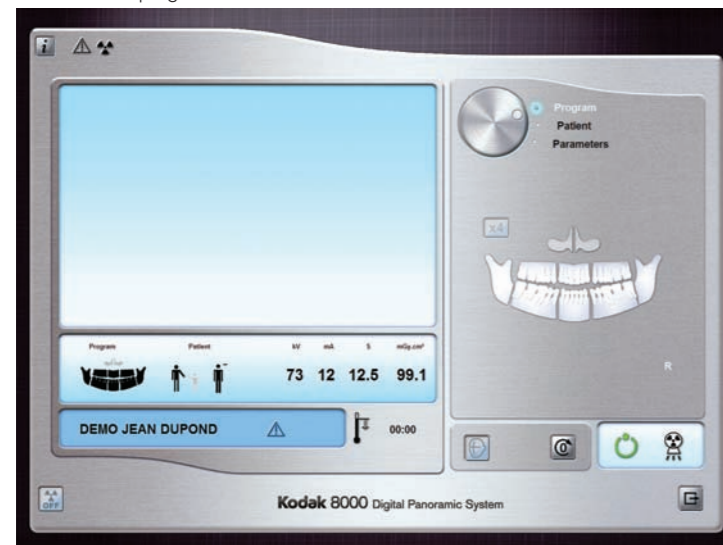

2. Enter patient information.



3. Set exposure parameters.



Effortless image processing

Need to modify your contrast?

Want to adjust the brightness?

With the Kodak 8000 system's powerful imaging software, you can do this and more. Image enhancement is made simple thanks to a full range of tools. From now on, analyzing images will be a totally new experience.

Enhanced image quality

Featuring the latest software processing algorithms, the improved Kodak 8000 system delivers clearer and sharper clinical details. The result: high-diagnostic value images.



1. Image without the new sharpness filter and with the new sharpness filter.

2. Reverse video for better perception of the radio-opaque areas.

3. Highlight effect: local contrast to highlight clinical details. Note the relationship between a wisdom tooth and mandibular canal.

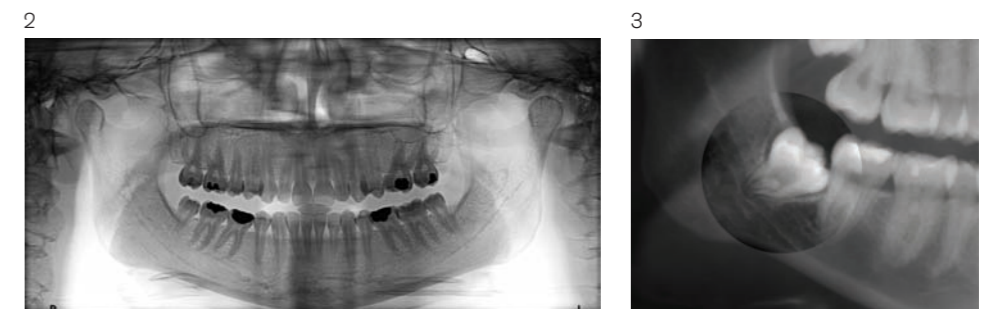

Instantaneous results

Three quick steps

The Kodak 8000 system speeds up your entire workflow. We've boiled down the process to three simple steps, all of which are designed for ease and speed.

Immediate acquisition

One of the benefits of digital technology is the ability to see your x-rays immediately. You can even stop the exam if you see something wrong during the acquisition.

More effective care

All in all, you will see a net decrease in down-time and a corresponding increase in productivity.

1. Set parameters.



2. Position the patient.



3. Capture the image in real-time.

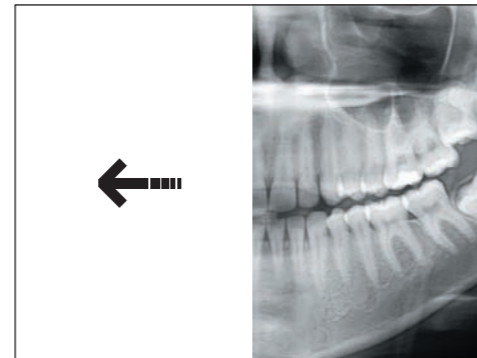

Multiple perspectives

Covers every angle

Capture all the shots you need and all the views you require for your basic examination needs.

Multiple views

One of the advantages of the Kodak 8000 system is that it offers an array of image possibilities. And, as you know, an accurate diagnosis requires the ability to look at it in several different ways.

1. The most common examination—the standard panoramic—lets you view the entire dental structure as well as surrounding bone and tissue.
2. The temporo-mandibular joints (TMJ) in four lateral views, mouth open and closed on the same image. This is particularly useful for detecting malformations in the crano-mandibular joint.
3. The temporo-mandibular joints in 2 lateral views, mouth open or closed.
4. The maxillary sinus.
5. The standard panoramic segmented program can isolate one or several sections, limiting patient exposure.

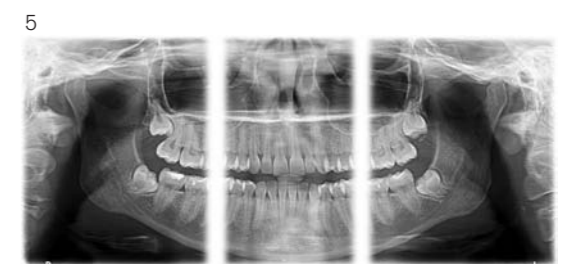
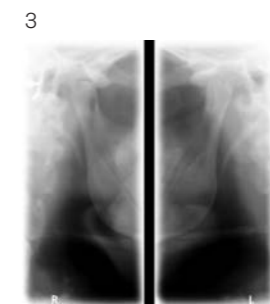
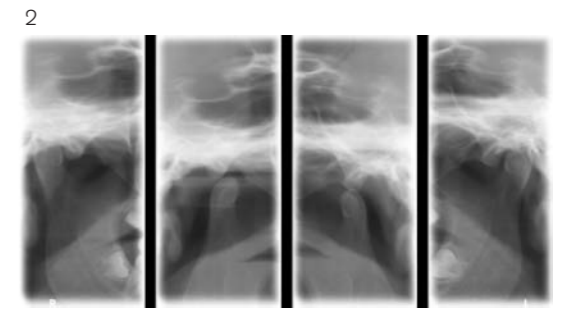

Completing the circle

Effortless integration

We designed the Kodak 8000 system to fit right into your current workflow. In fact, our software serves as the control base for each and every Kodak dental imaging system.

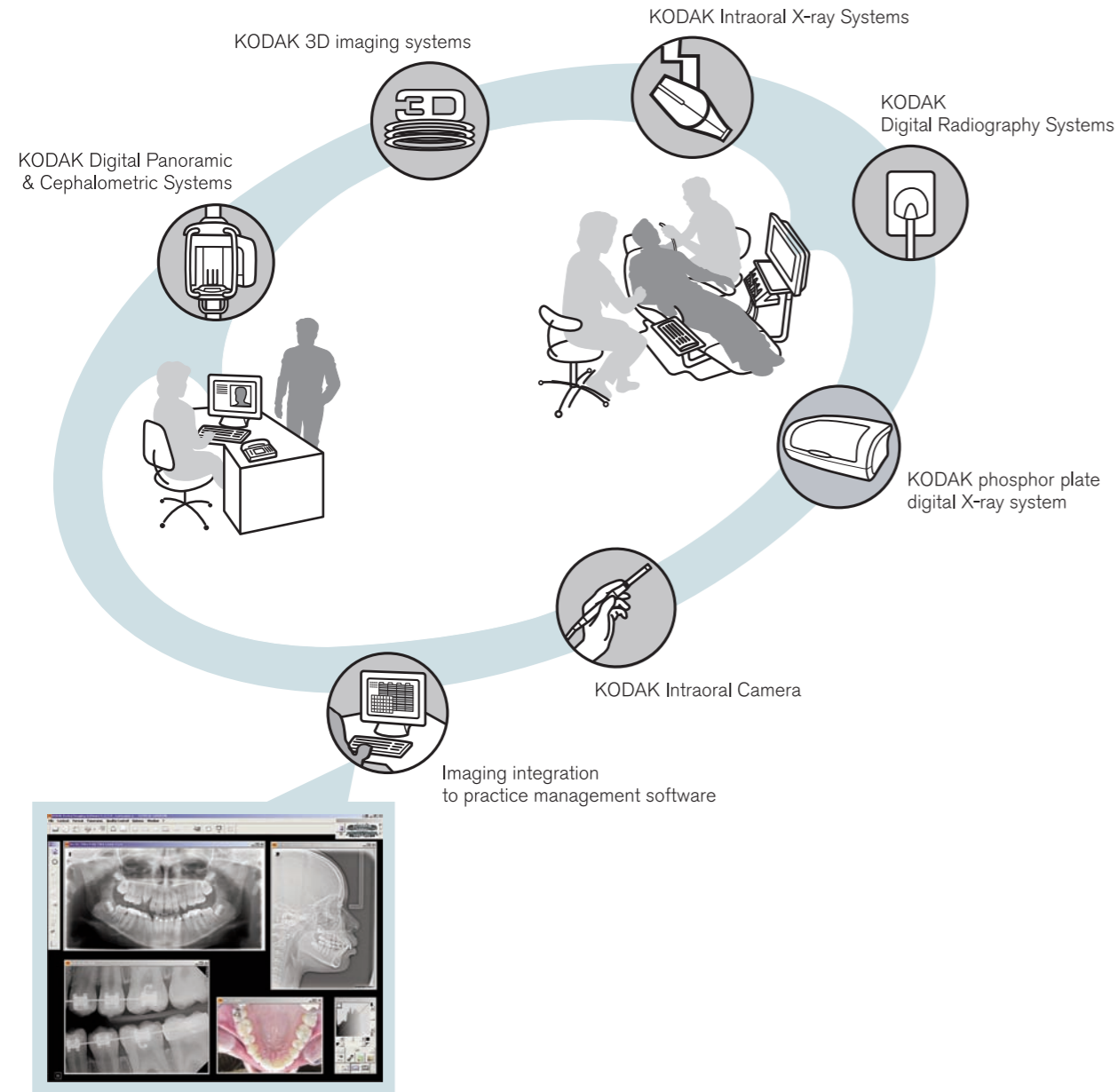

Effective image management

Powerful software

You have the image—now you need the ability to share, print, or file it. With Kodak dental imaging software, you can do all three.

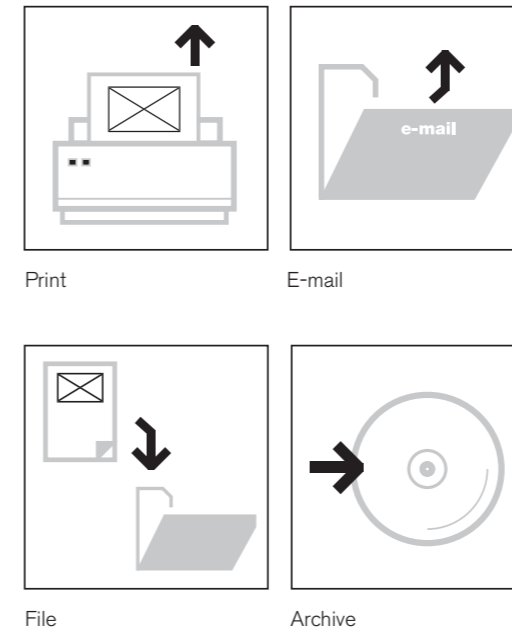

Digital and straightforward

With just one click, you can save your image and its associated parameters. You can even add comments and notes. Digital technology also means that, regardless of how many times you print, copy, or retrieve your images, you don't have to worry about loss of quality.

Highly compatible

Because Kodak dental imaging software is fully DICOM-compatible, it's a snap to integrate it into your workflow. In no time at all, you can transfer and send images to the media of your choice. The possibilities are endless.

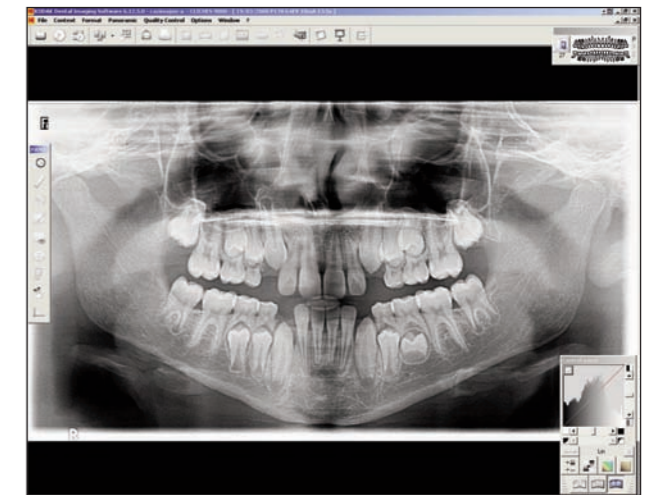

The clear and user-friendly interface is designed for diagnostic effectiveness.



Flexible display, powerful image processing and image management tools.



Reliability at its best

Peace of mind

As the exclusive manufacturer of Kodak dental systems, we are the company dental professionals across the world trust for all of their diagnostic imaging needs. Designed to protect your investment, our products offer the reliability and long service life you need to get the most out of your investment.

Support you can depend on

With a team of dedicated support experts, we are committed to providing our customers with the seamlessly integrated system they demand. That's why our support team is here to provide the guidance you need—before, during, and after the sale.

The high frequency advantage

Constant radiation

Powered by a high-frequency generator, the Kodak 8000 system delivers the safest examination possible. The system's technology ensures that radiation remains constant during the exposure—so you receive better, safer images.

Better, safer images

The results are remarkable. With the Kodak 8000 system, you get high-contrast images with homogenous image density. And best of all, the high-frequency generator does it all with less radiation exposure than conventional generators.



▲ Just one example of the remarkable results you'll obtain quickly and effortlessly with the improved version of the Kodak 8000 system.



Take it in one shot

Totally unique

The Kodak 8000C system features one-shot technology to deliver faster, more accurate images.

Instant exposure, real-time imaging, and a user-friendly interface ensure you receive the high-caliber results you need.

And with the system's newly designed cephalometric module and Ethernet connection, the Kodak 8000C system can be easily installed into any dental practice.

One Shot. High-Quality Results.

Kodak 8000C
Digital Panoramic and Cephalometric System



Incredibly effective

Blink of an eye

Unlike older scanning techniques, the Kodak 8000 system uses one-shot technology to expose the skull in one single shot—and all in just over a second.

Easier on patients

The system's projected image system significantly reduces the likelihood that your patients will move during the exam. In fact, they only have to stay still for less than one second.

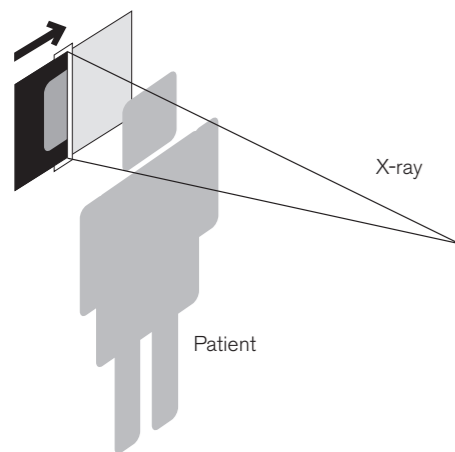

▲ Scanning: Older systems produce an image by sweeping patients with X-rays. Patients must remain immobile during the 8 to 14 seconds the sweeping process requires.

Better images

Improved patient comfort. State-of-the-art technology. When you combine these features, you'll literally see the results: clearer, more precise images.

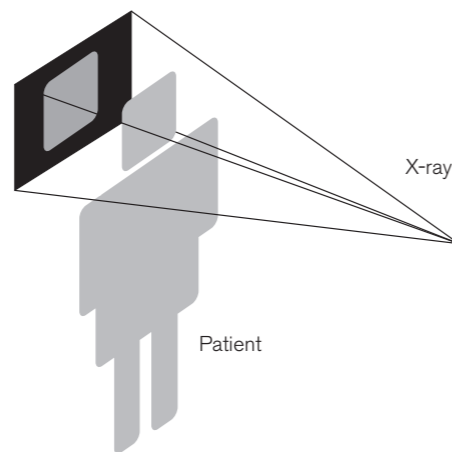

▲ One shot: Patients' craniums are exposed all at once in less than one second. The result: drastically reduced risk of blurriness due to patient movement.

Easy to program

Look and learn

The controls of the Kodak 8000C system are completely user-friendly. There's hardly any training necessary—in fact, you can easily operate the unit without a user's manual. It's even simple for your patients—making it a useful communication tool. And best of all, all the programming happens directly on your computer.

Blends right in

You'll find the Kodak 8000C system fits into your current workflow without a hitch. You'll achieve an uninterrupted workflow that allows you to provide the best possible care.



Meeting high expectations

Always improving

We are committed to you. That's why we are constantly working to improve our products—the new version of the Kodak 8000C system is just one example of this.

First-class

All of the Kodak 8000C system's features are top of the line. The high-frequency generator ensures that you don't have to sacrifice image quality for safety.

The included image analysis software can help improve your diagnoses. With features such as bone and edge enhancement filters, you'll get the level of detail you need to make accurate, confident diagnoses—each and every time.

Tracing and landmark identification will also be far simpler, faster, and clearer. You'll see bone density and edge enhancement appear right before your eyes.



1



2

1. Bone enhancement for a clear visualization of bone and cartilage.
2. Edges enhancement for a better visualization of both hard and soft tissues for fast tracing.

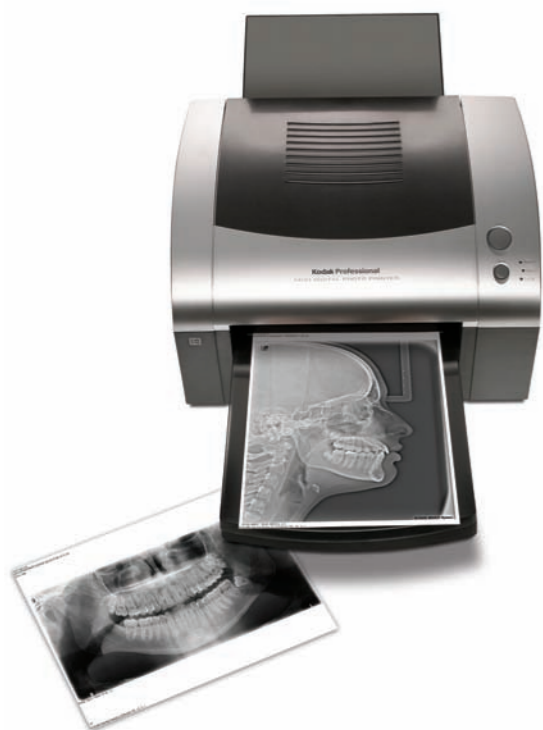

KODAK 8000 / 8000C Systems

Technical specifications

Generator	High Frequency (max. 140 kHz)
Focal Spot size	0.5 mm (IEC 336)
Total filtration	> 2.5 mm eq. Al
Tube voltage	60-90 kV
Tube current	2-15 mA
Line voltage	230-240 V / 50 Hz 230-240 V / 60 Hz 110-130 V / 60 Hz
Exposure time	Adult panoramic : 13.9 s. Pediatric panoramic: 13.2 s. Maxillary sinus: 10.7 s. Lateral TMJ, 2 sections: 4.6 s. Lateral TMJ, 4 sections: 9.2 s. Cephalometric images: 0.1 - 3.2 s.
Magnification	Pan: 1.27 Ceph: 1.14
Weight	Kodak 8000 system: 120 kg Kodak 8000C system: 145 kg
Grey scale	16384 (14bits)
Sensor dimension	Pan: 64 x 1348 pixels Ceph: 1360 x 1840 pixels
Image field	Pan: 6.1 x 129.4 mm Ceph: 195 x 263 mm

Unit dimensions

KODAK 8000 System

Front view

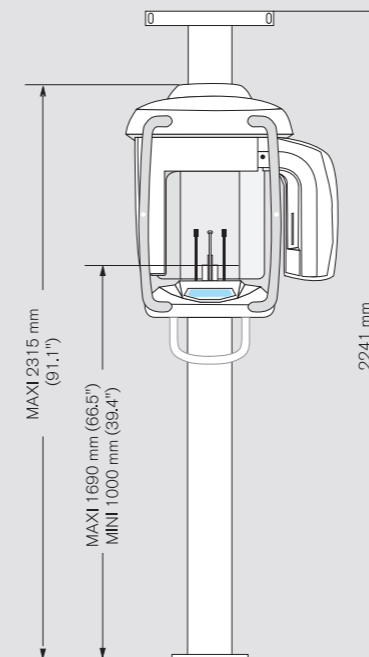

Top view

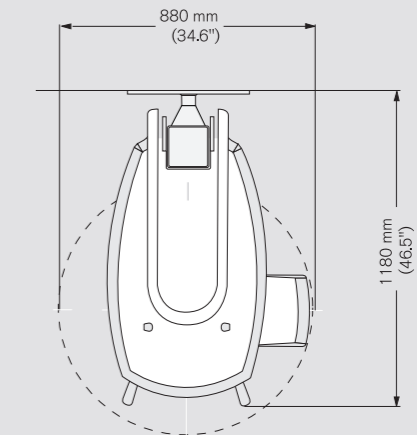

KODAK 8000C System

Front view

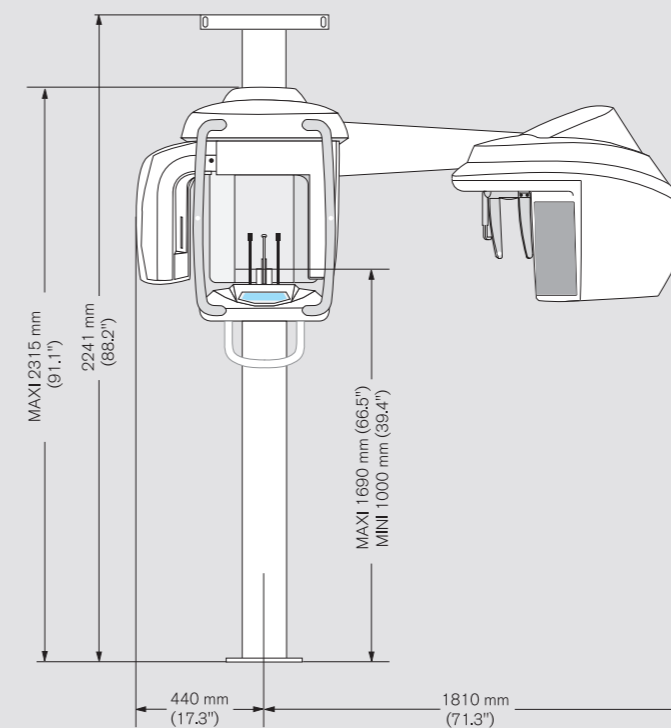

Top view

